

# Инструкция по установке **HYUNDAI CRETA**

(2016-2021; 2021-)



ВИДЕОИНСТРУКЦИЯ



Арт.: F.2312.002

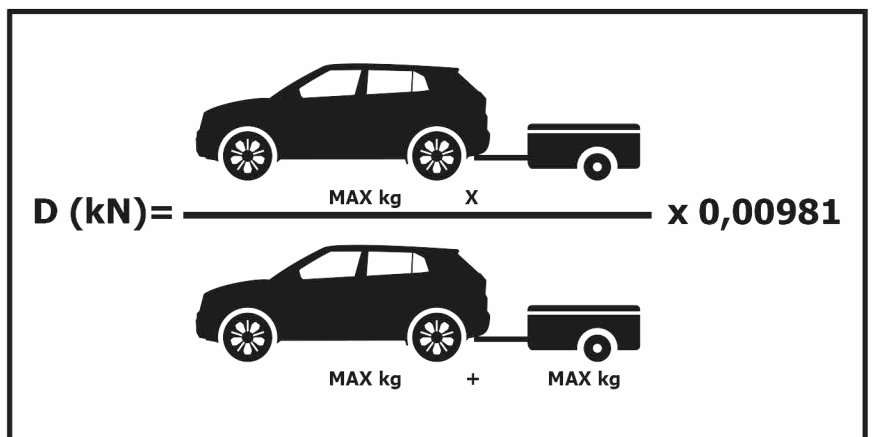
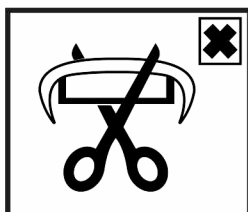
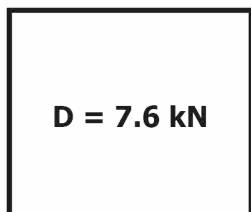
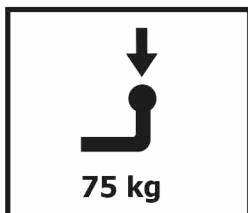
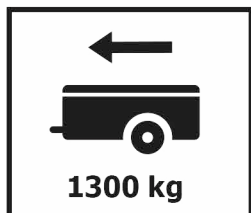

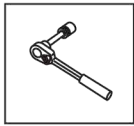

Вкрутить/выкрутить используя инструмент

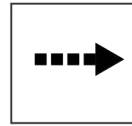

Движение

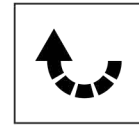

Поворот



Вкрутить/выкрутить не затягивая

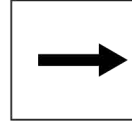





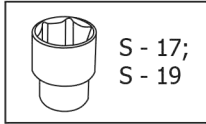
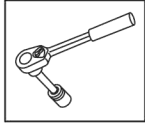



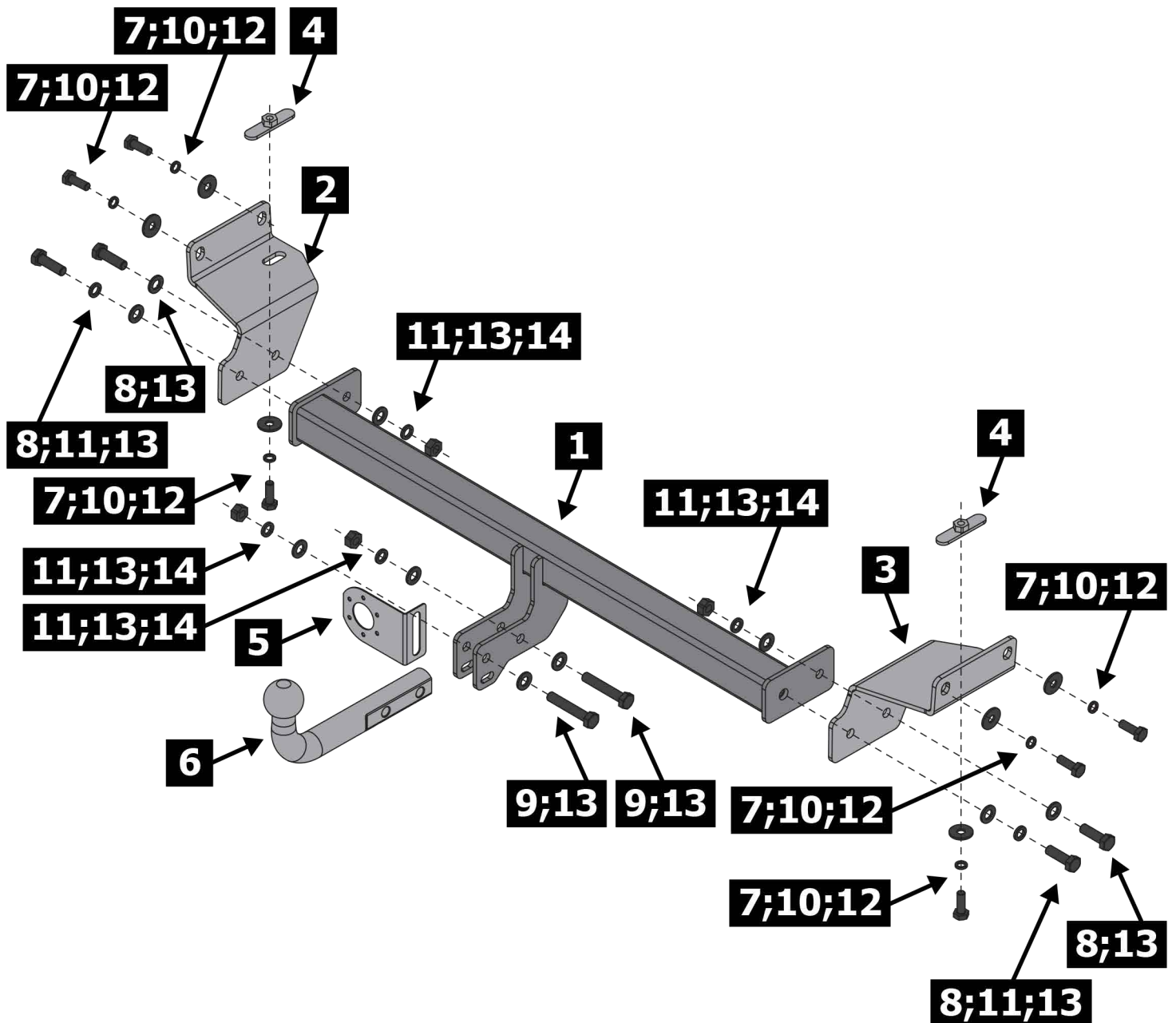

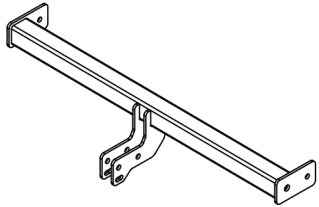
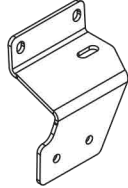
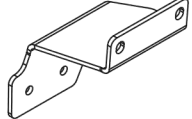
Расположение

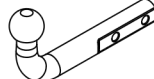
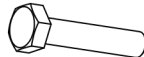
### Используемый инструмент:



S - 17;  
S - 19



<b>1</b>	x1	Балка	
<b>2</b>	x1	Кронштейн левый	
<b>3</b>	x1	Кронштейн правый	
<b>4</b>	x2	Закладная гайка	
<b>5</b>	x1	Подрозетник	
<b>6</b>	x1	Крюк	
<b>7</b>	x6	M10x1.25x30	
<b>8</b>	x4	M12x1.25x40	
<b>9</b>	x2	M12x1.25x70	
<b>10</b>	x6	Ø 10	
<b>11</b>	x6	Ø 12	
<b>12</b>	x6	Ø 10	
<b>13</b>	x10	Ø 12	
<b>14</b>	x4	M12x1.25	

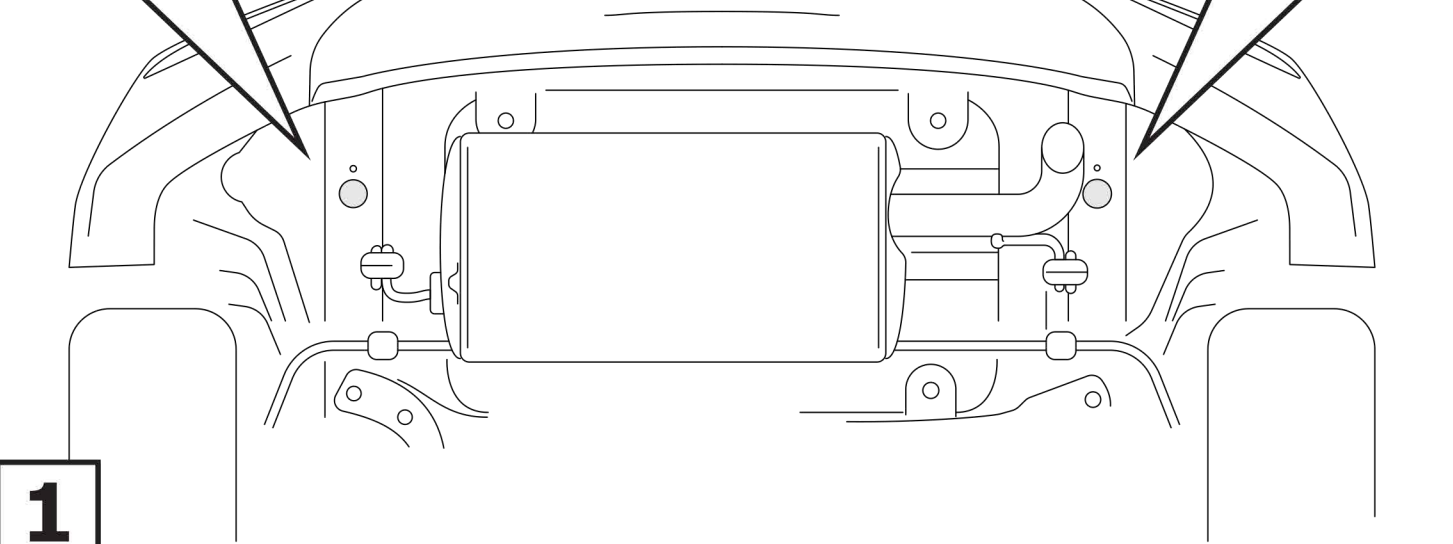
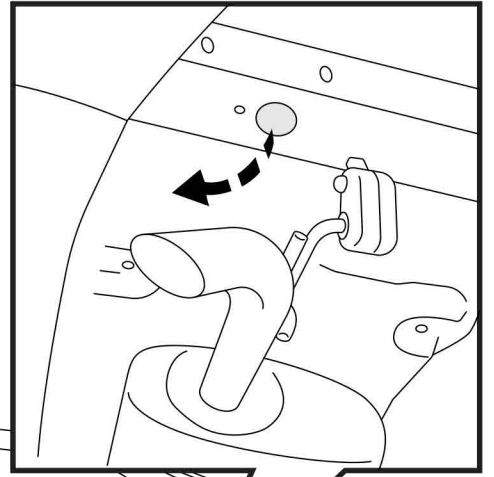
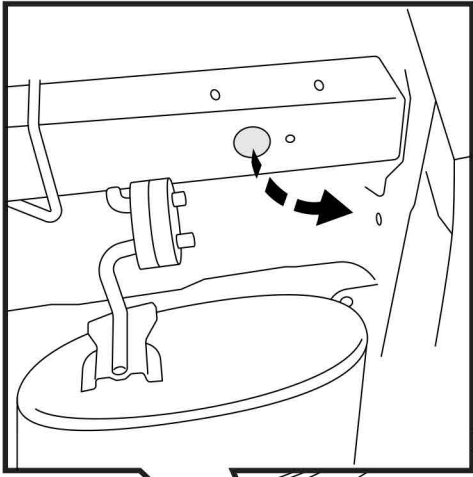

**1**

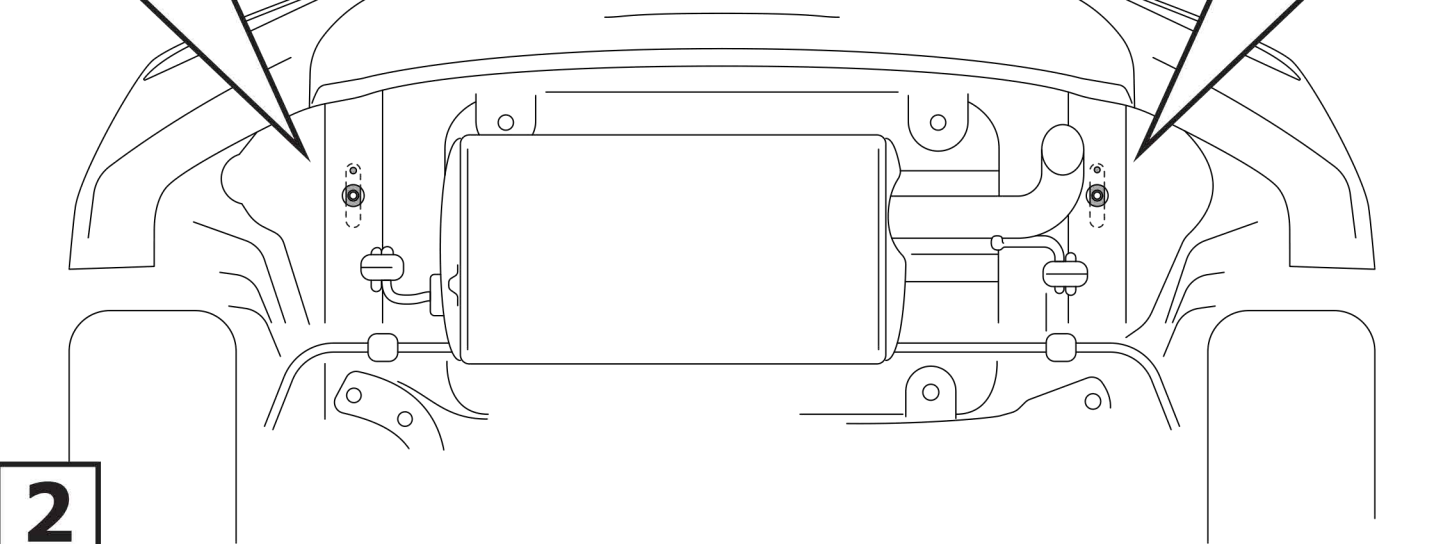
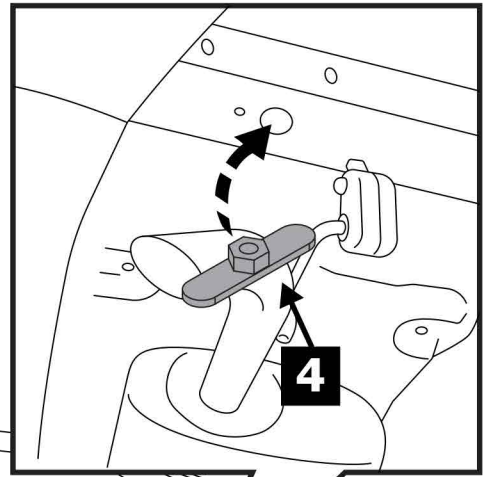
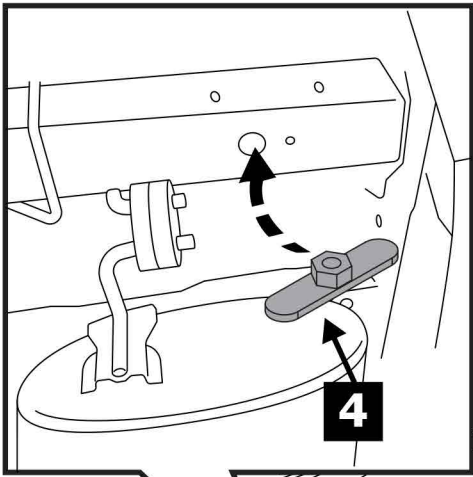

**2**

