

## Thule Sprint 569

# > Instructions



www.thule.com  
ID 1000000000

**CITY CRASH**

Complies with ISO norm



WingBar

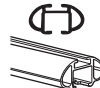

AeroBar



SlideBar



ProBar

**569000**

C.20141020  
501-7906-02

**EN** Roof-mounted bike carrier  
**DE** Dachfahrradträger  
**FR** Porte-vélo sur le toit  
**NL** Fietsdrager voor op het dak  
**IT** Portabici da installare sul tetto  
**ES** Portabicicletas de techo  
**PT** Suporte para bicicleta para teto  
**SV** Takmonterad cykelhållare  
**DK** Tagmonteret cykelholder  
**NO** Takmonterte lasteholdere  
**FI** Katolle asennettava polkupyöräteline  
**ET** Katusele paigaldatav jalgrattahoidik  
**LV** Uz jumta uzstādāms velosipēdu turētājs  
**LT** Ant stogo tvirtinami dviračių laikikliai  
**PL** Bagażnik rowerowy montowany na dachu  
**RU** Устанавливаемое на крыше крепление для велосипедов

**UK** Багажник для велосипедів, що монтується на даху  
**BG** Покривен багажник за велосипеди  
**CS** Nosič jízdních kol s montáží na střechu  
**SK** Nosič bicyklov s montážou na strechu  
**SL** Nosilec za kolesa  
**HR/BiH** Krovni nosač bicikla  
**RO** Suport pentru bicicletă montat pe pavilion  
**HU** Tetőre szerelhető kerékpártartó  
**EL** Σχήμα ποδηλάτου οροφής  
**TR** Araç üstüne bağlanan bisiklet taşıyıcı  
 حامل الدراجة للتثبيت على السقف  
**HE**  
**AR**  
**ZH** 頂置自行車架  
**JA** ルーフマウント型サイクルキャリア  
**KO** 지붕 장착 자전거 캐리어  
**TH** โคร่งยึดจับจักรยานแบบติดตั้งบนหลังคา

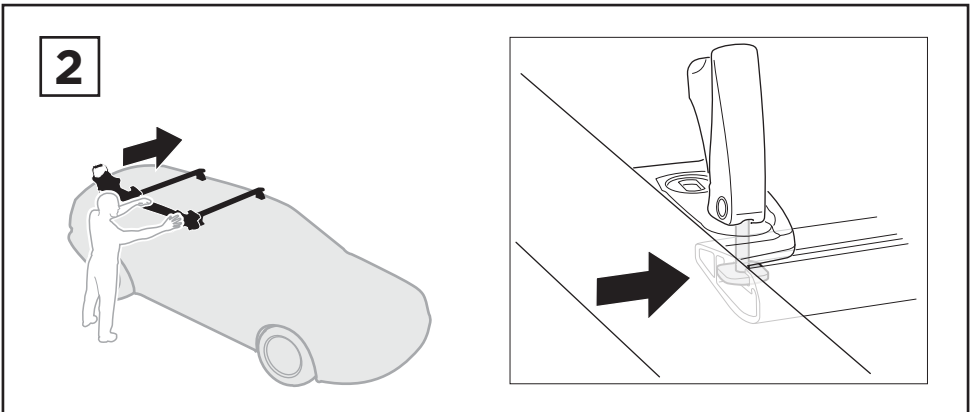
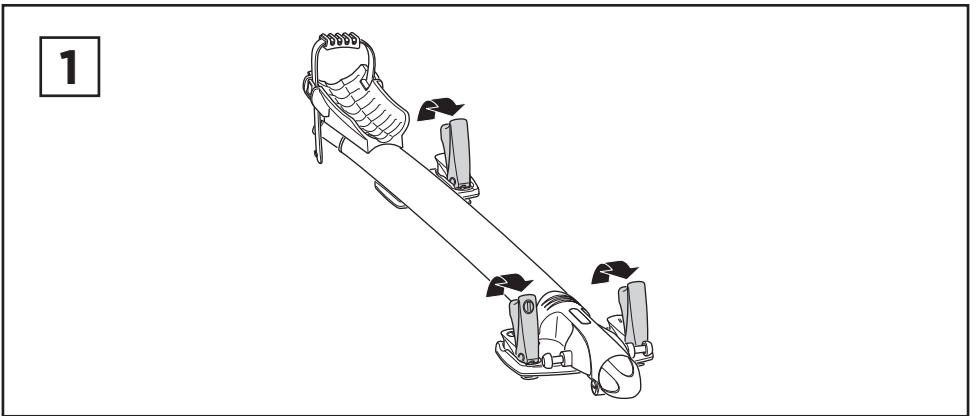
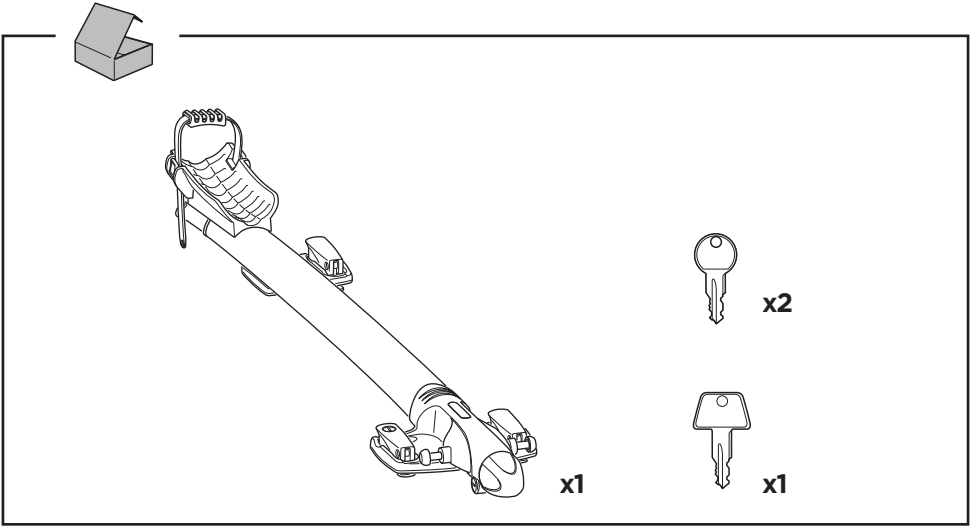

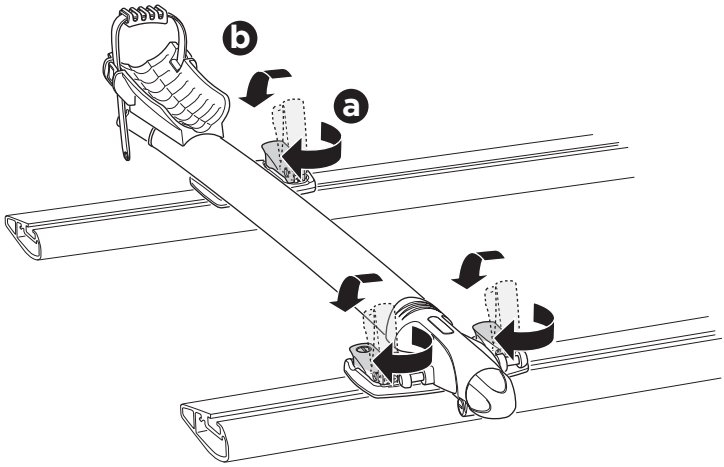
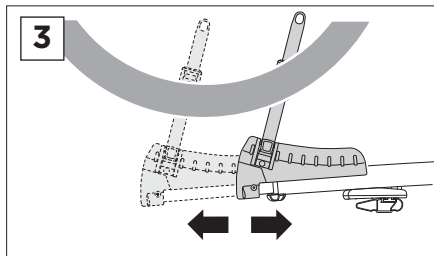
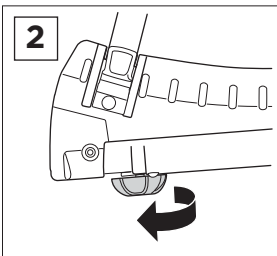
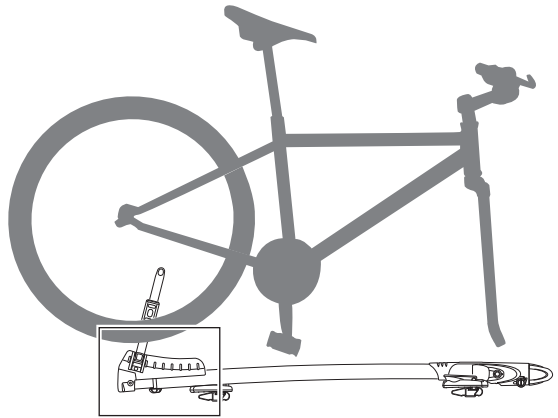
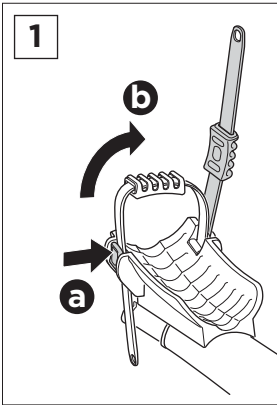
**3****4**

5



2

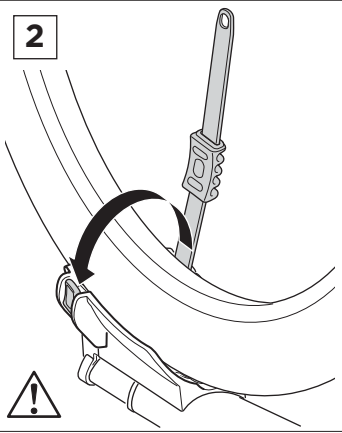

3

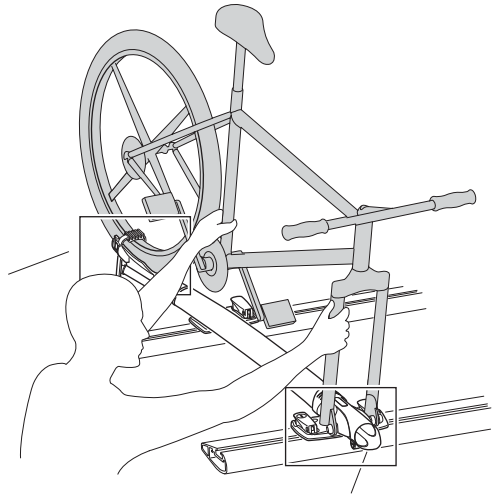
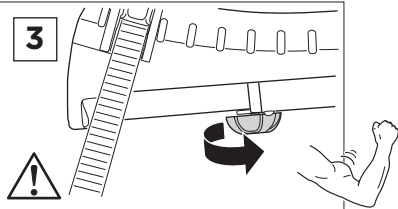

1

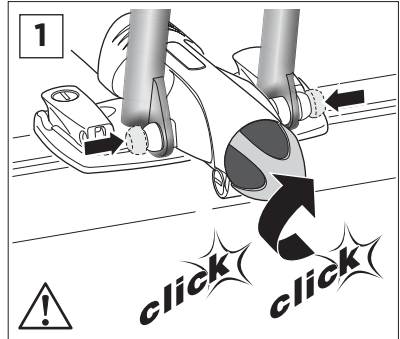

6

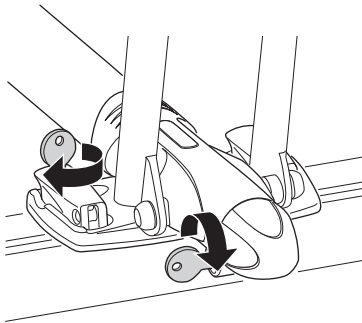

<b>EN</b> Left-hand fitting	<b>BG</b> Монтаж отляво
<b>DE</b> Montage links	<b>CS</b> Montáž z levé strany
<b>FR</b> Montage côté gauche	<b>SK</b> Montáž na ľavej strane
<b>NL</b> Montage aan de linker kant	<b>SL</b> Pritrjevanje z leve strani
<b>IT</b> Montaggio a sinistra	<b>HR/BIH</b> Montaža s lijeve strane
<b>ES</b> Montaje a izquierda	<b>RO</b> Montare pe partea stângă
<b>PT</b> Montagem do lado esquerdo	<b>HU</b> Bal oldalról szerelhető
<b>SV</b> Vänstermonterad	<b>EL</b> Τοποθέτηση αριστερά
<b>DK</b> Venstremontering	<b>TR</b> Sol elle montaj
<b>NO</b> Venstremontering	التركيب في الجانب الأيسر <b>AR</b>
<b>FI</b> Asennus vasemmalta	תהקנה שמאלית <b>HE</b>
<b>ET</b> Vasakpoolne kinnitamine	<b>ZH</b> 从左侧安装
<b>LV</b> Kreisais stiprinājums	<b>JA</b> 左手装着
<b>LT</b> Kairysis pritvirtinimas	<b>KO</b> 왼손 장착
<b>PL</b> Montaż z lewej	<b>TH</b> ตัวยึดด้านซ้ายมือ
<b>RU</b> Установка на левую сторону	
<b>UK</b> Установка на ліву сторону	

**i**

x1

x1

**1**

**a**

**b**

**2**

**a**

**b**

**c**

**i**

**1**

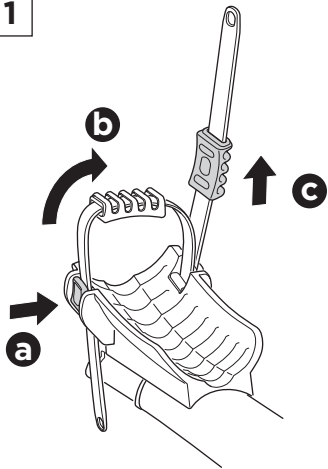

**2**

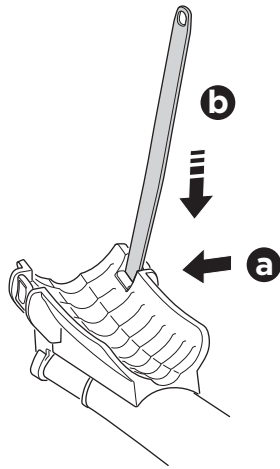

**3**

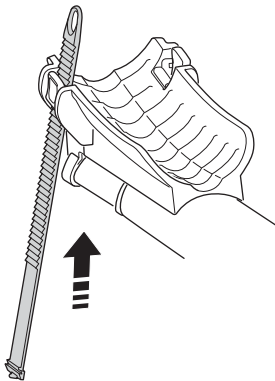

**4**

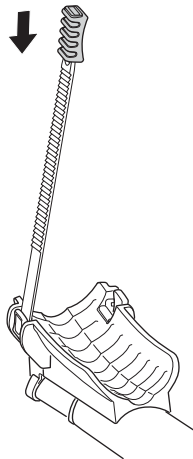

**EN** Accessories  
**DE** Zubehör  
**FR** Accessoires  
**NL** Accessoires  
**IT** Accessori  
**ES** Accesorios  
**PT** Acessórios  
**SV** Tillbehör  
**DK** Tilbehør  
**NO** Tilbehør  
**FI** Lisävarusteet  
**ET** Lisavarustus  
**LV** Piederumi  
**LT** Priedai  
**PL** Akcesoria  
**RU** Аксессуары

**UK** Аксессуары  
**BG** Принадлежности  
**CS** Dopřloky  
**SK** Príslušenstvo  
**SL** Dodatki  
**HR/BiH** Dodaci  
**RO** Accesorii  
**HU** Tartozékok  
**EL** Εξαρτήματα  
**TR** Aksesuarlar

AR الملحقا  
 HE אביזרים

**ZH** 附件  
**JA** アクセサリー  
**KO** 액세서리  
**TH** อุปกรณ์เสริม

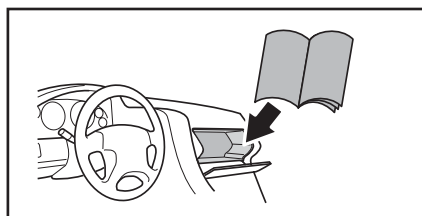
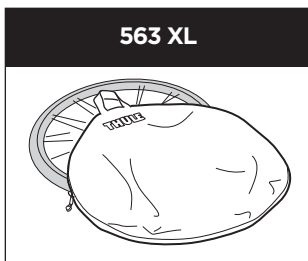
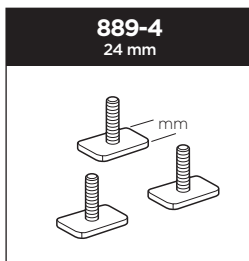
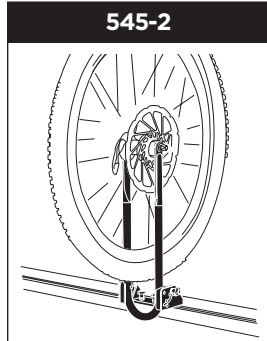

## Thule One-Key System

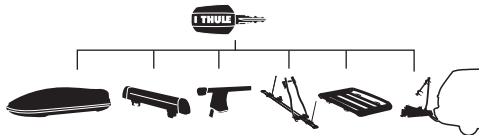

**544**  (x4)  
**596**  (x6)  
**588**  (x8)  
**452**  (x12)